



UBA Sectie TRA



Snel aan de slag in FT8 mode

Voordracht door ON7EQ

Jean-Jacques

17-11-2017

? FT-8 ... enkele quotes

- *'FT8 Mode is Latest Bright Shiny Object in Amateur Radio Digital World'*
- *'More and more stations and DXpeditions are using the new FT8 mode'*
- *'FT-8 Pinnacle of perfection overcoming paltry sunspots and raging solar storms to provide incredible results on seemingly dead bands'*
- *'FT-8 Digital Mode Has Taken Over The HF Bands!'*

1.500 QSO / 3 mnd / 50w / Ant mobile whip 1m50

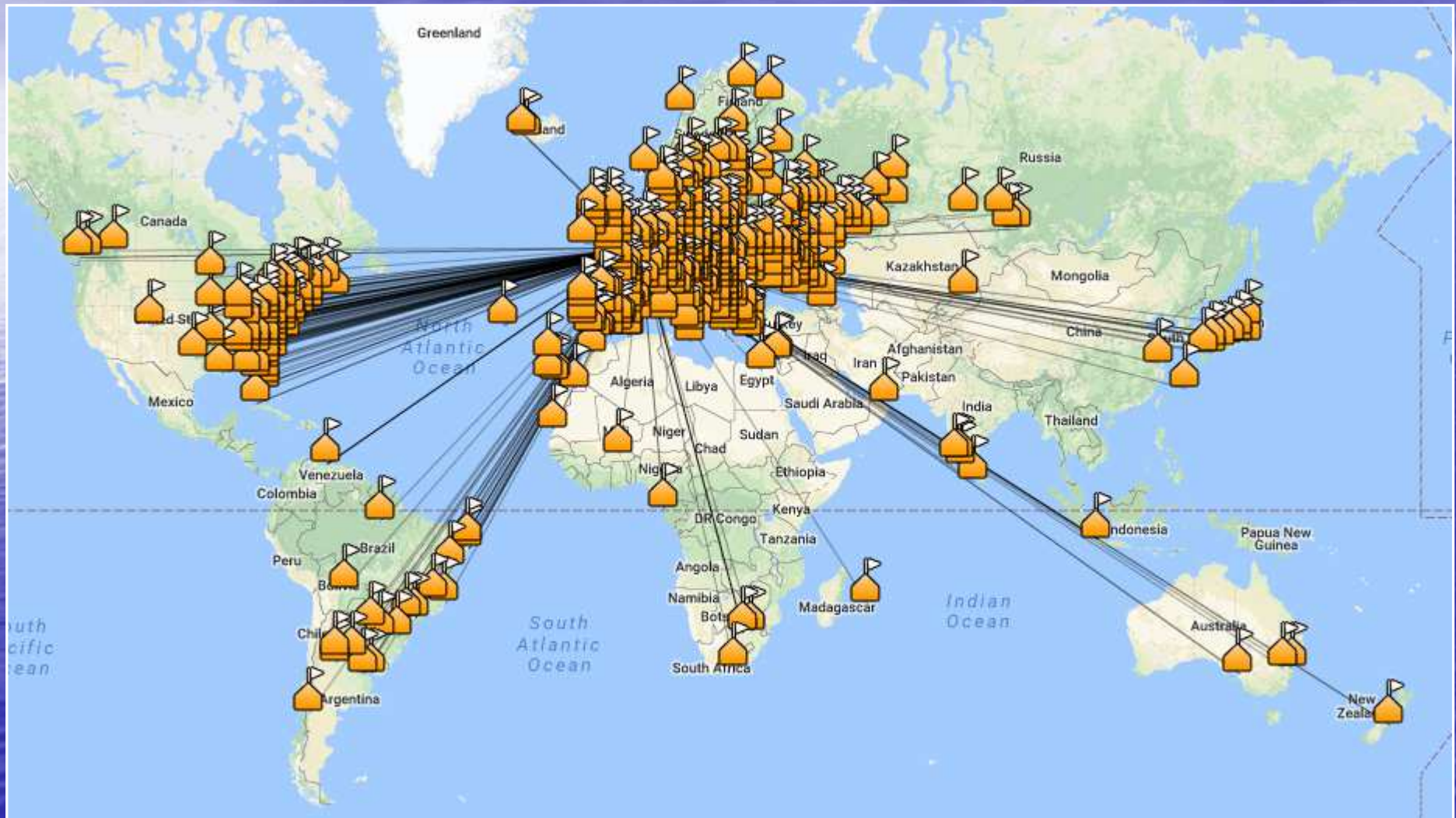

? Digitale modes ... > 25 !

- RTTY
- AMTOR – ARQ
- SITOR
- PACTOR & PACTOR II
- G-TOR
- FEC (NAVTEX, SITOR-B)
- COQUELET
- CLOVER
- CHIP
- PSK31 (BPSK, QPSK), PSK63, PSK125,
- HF PACKET (300 baud)

? Digitale modes ...*vervolg* !

- HELLSCHREIBER
- MT63
- THROB 1, 2, 3, 4
- MFSK16, MFSK8
- JT65-A
- JT-4, JT-9, JT-9A, QRA-64
- OLIVIA (PAX, PAX2)
- CONTESTIA
- DOMINO EX
- HAM DRM
- THOR 4, 5, 8, 11, 16 and 22
- ROS 16 baud, 8 and 4 baud (Spread Spectrum=legaal?)
- HFDL

? Digitale modes ...

Groot verschil : **ASYNCHROON** of **SYNCHROON**

ASYNCHROON :

- TX en RX niet op vastgesteld tijdsrooster
- Inhoud boodschappen niet gestructureerd
- Geen vastgestelde afhandeling QSO

SYNCHROON :

- TX en RX op vastgesteld tijdsrooster
- Inhoud boodschappen gestructureerd
- Vastgestelde afhandeling QSO

? Digitale modes ...

VOORDELEN **SYNCHRONE** PROTOCOLLEN ?

- Beter geschikt voor zwakke signalen (AP ?)
- Snellere afhandeling QSO (automatisch)
- Efficiënte bezetting spectrum (FT8 : 50 QSO's)

Ontwikkelaar WS software

- Joe Taylor - K1JT
- Astrofysicus USA
- 1993 Nobelprijs
Natuurkunde voor
ontdekking Pulsars



→ **WSJT-X = 'core' van systeem**

FT8 : even voorstellen ...

- Geïntroduceerd in juli 2017
- K9AN Steve **F**ranke en K1JT Joe **T**aylor
(Franke-Taylor design, **8**-FSK modulation)
- Zwakke signalen, met snelle QSB
- Snel succesvol QSO = 1 à 2 min.
- T/R cyclus : 15s (13,5s signaal)
- FEC, 8 toons, bandbreedte amper 47 Hz

FT8 : even voorstellen ...

- Decoding -20 tot -24dB ! (AP = A Priori ?)
- Multidecoding: alle signalen in de passband
- Tijdssynchronisatie : DT tot 2,5 s
- Berichten : max 13 karakters 'kort'
- Na beta versie RC3, nu 'final' release
- Mode herkend door ADIF & LoTW

FT8 : Verloop van een QSO

Tijdssynchroon systeem : 1 seq = 15s

'TX FIRST/EVEN' : 00-15 en 30-45 sec

'TX SECOND/ODD' : 15-30 en 45-60 sec

Keuze is vrij !

FT8 : Verloop van een QSO

**Korte boodschappen, minimum voor
geldig QSO:**

- Calls uitwisselen**
- Rapport uitwisselen**
- Bevestiging ontvangst rapport**
- Als afsluiter normaal : 73 of RR73**

FT8 : Verloop van een QSO

Voorbeeld bij CQ geven:

CQ ON7EQ JO11

ON7EQ ZS2PA KF26

ZS2PA ON7EQ -10

ON7EQ ZS2PA R-12

ZS2PA ON7EQ RRR (of RR73)

ON7EQ ZS2PA 73

ZS2PA ON7EQ 73

FT8 : Verloop van een QSO

Voorbeeld bij CQ beantwoorden

CQ ZS2PA KF26

ZS2PA ON7EQ JO11

ON7EQ ZS2PA -10

ZS2PA ON7EQ R-12

ON7EQ ZS2PA RRR (of RR73)

ZS2PA ON7EQ 73

ON7EQ ZS2PA 73

FT8 : Verloop van een QSO

Voorbeeld bij stn oproepen

DL5HP ZS2PA 73 (loc ?)

ZS2PA ON7EQ JO11 (of -12)

ON7EQ ZS2PA -10 (of R-10)

ZS2PA ON7EQ R-12 (of RRR / RR73)

ON7EQ ZS2PA 73

ZS2PA ON7EQ 73

FT8 - Welk materiaal is vereist ?

TRANSCEIVER :

- **Power : 10 → 50 W**
- **STABIEL in frequentie**
- **USB sound IFC = OK !**
- **Audio passband 2.4 kHz: geen DSP, geen audio filter**
- **CAT control is best handig !**

FT8 - Welk materiaal is vereist ?

PC/LAPTOP → WSJT-X software :

- Standaard PC
- WinXP, Win 7, , Linux, OSX
- Soundcard in/out of USB, PTT

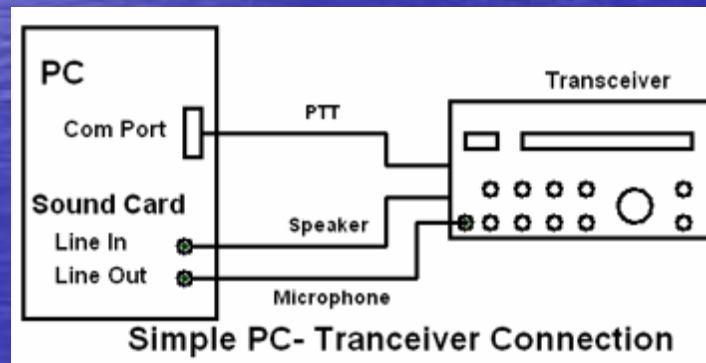

- Internet connectie (of GPS) (tijd)

Software omgeving:

- **WSJT-X software** : **WSJT-X v1.8.0 r8193**

<https://physics.princeton.edu/pulsar/k1jt/wsjtx.html>

- **Aanbevolen als extra (enkel op Windows):**
 - NetTime (tijdssynchronisatie)
 - JT-Alert : Alarm + interface logging
 - OmniRig : CAT control → flexibeler !
- PSK Reporter → check propagatie
ALLES = FREEWARE !

Software omgeving: timesync

Windows heeft time sync maar deze is niet precies genoeg, drift PC klok 1 à 5 sec / dag → en maximum 1 seconde offset (DT) aanbevolen !

- **TARDIS2000 (Win XP, Win 7?)**
- **Beste : NetTime !**



→ Instellen zodat bij opstart van de PC deze gaat synchroniseren met atoomklok, en daarna bvb. om de 1 à 4u

TimeSync instellingen - voorbeeld

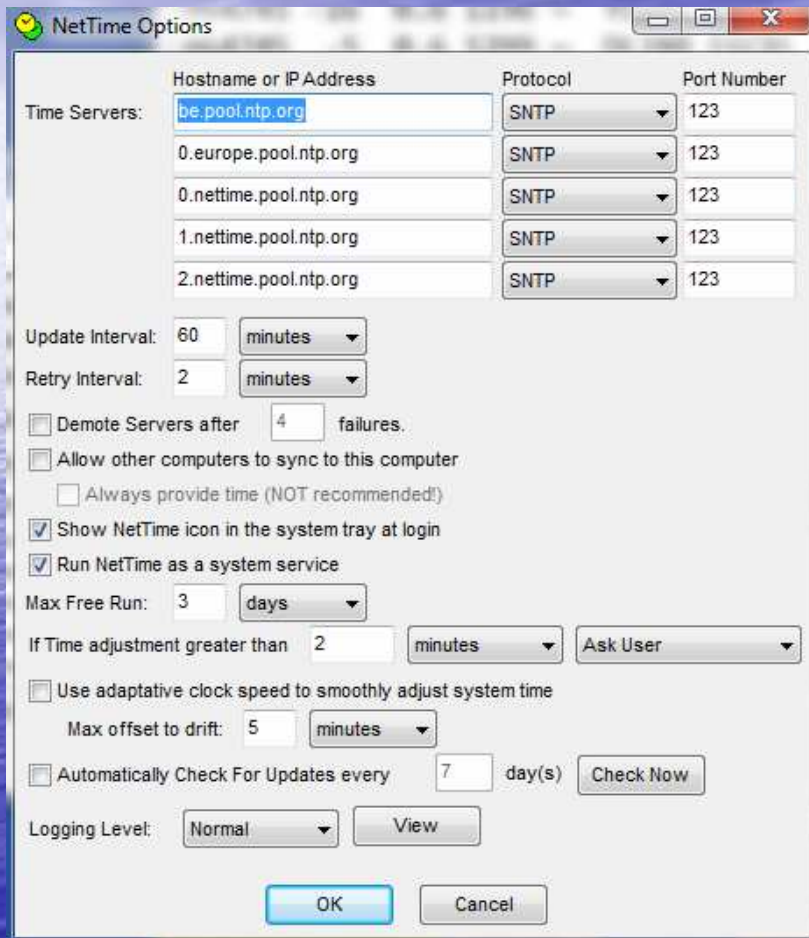

NetTime Options

Time Servers:	Hostname or IP Address	Protocol	Port Number
	be.pool.ntp.org	SNTP	123
	0.europe.pool.ntp.org	SNTP	123
	0.nettime.pool.ntp.org	SNTP	123
	1.nettime.pool.ntp.org	SNTP	123
	2.nettime.pool.ntp.org	SNTP	123

Update Interval: 60 minutes
Retry Interval: 2 minutes

Demote Servers after 4 failures.
 Allow other computers to sync to this computer
 Always provide time (NOT recommended!)
 Show NetTime icon in the system tray at login
 Run NetTime as a system service

Max Free Run: 3 days
If Time adjustment greater than 2 minutes Ask User

Use adaptive clock speed to smoothly adjust system time
Max offset to drift: 5 minutes

Automatically Check For Updates every 7 day(s) Check Now

Logging Level: Normal View

OK Cancel

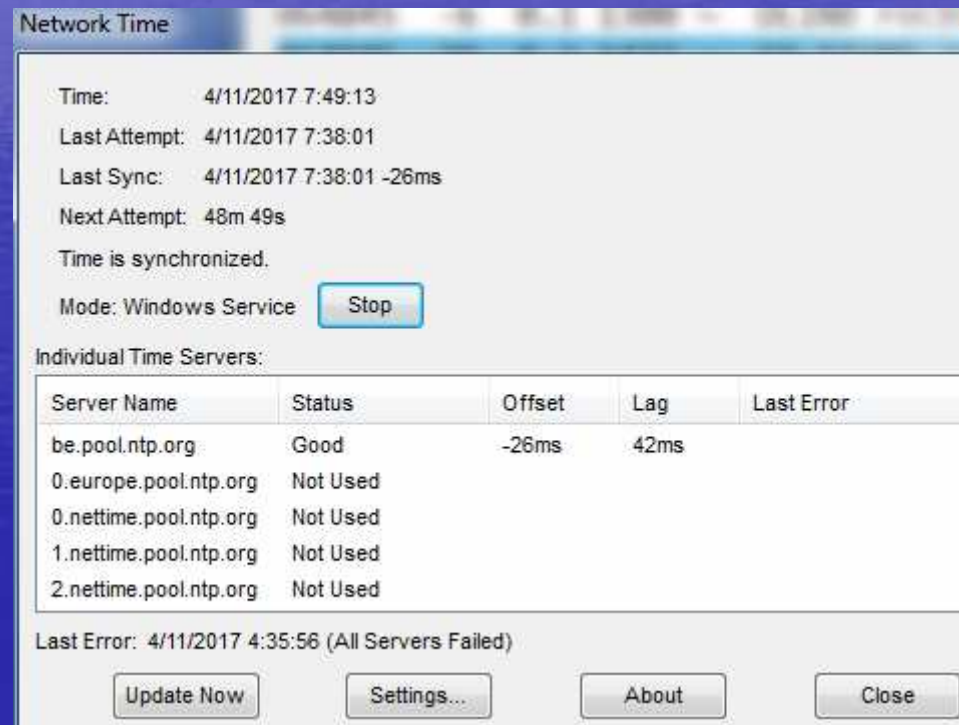

Network Time

Time: 4/11/2017 7:49:13
Last Attempt: 4/11/2017 7:38:01
Last Sync: 4/11/2017 7:38:01 -26ms
Next Attempt: 48m 49s
Time is synchronized.
Mode: Windows Service Stop

Individual Time Servers:

Server Name	Status	Offset	Lag	Last Error
be.pool.ntp.org	Good	-26ms	42ms	
0.europe.pool.ntp.org	Not Used			
0.nettime.pool.ntp.org	Not Used			
1.nettime.pool.ntp.org	Not Used			
2.nettime.pool.ntp.org	Not Used			

Last Error: 4/11/2017 4:35:56 (All Servers Failed)

Update Now Settings... About Close

Software omgeving: logging

WSJT-X : maakt een ADIF bestand → import mogelijk

Maar JT-Alert : directe LOGGING met DUPES check !

- **DXLab DXKeeper**
- **ACLog**
- **Log40M**
- **HRD Log V5**
- **Standard ADIF 2.2 file**
- **MixW (CSV file)**

Software omgeving: CAT control

CAT wordt binnen WSJT-X native ondersteund, maar niet gedeeld met bvb. je logprogramma. Met OmniRig wel sharing van 1 COM poort mogelijk ! Ondersteunde radios :

- TS-440, TS-480, TS-570, TS-590, TS-690, TS-850, TS-870, TS-930, TS-2000, all other Kenwoods
- FT-100D, FT-450, FT-747, FT-757, FT-817, FT-840, FT-847, FT-857, FT-897, FT-900, FT-920, FT-950, FT-990, FT-991, FT-1000, FT-1000MP, FT-2000, FT-9000, FTDX-3000, FT-DX5000MP
- IC-78, IC-275H, IC-703, IC-706MKII, IC-706MKiiG, IC-718, IC-725, IC-726, IC-728, IC-735, IC-737, IC-738, IC-746, IC-746Pro, IC-751, IC-756, IC-756Pro, IC-756ProII, IC-756ProIII, IC-761, IC-765, IC-775, IC-781, IC-821, IC-910, IC-970D, IC-7000, IC-7100, IC-7200, IC-7300, IC-7315, IC-7410, IC-7600, IC-7700, IC-7800, IC-7850, IC-7851, IC-9100, IC-R75, IC-R8500, IC-R9000, IC-M70
- CODAN, Elecraft K2, Elecraft K3, Ten-Tec Eagle, Ten-Tec Paragon II, Ten-Tec Orion, Ten-Tec Jupiter, Ten-Tec Omni VI+, Ten-Tec Omni VII, TenTec RX-350, JST-245, DX-77, NRD-535(DG), PowerSDR, Perseus, FRG-100, ZS-1, Elad-FDMSW2, ADT-200A, AOR AR5000, AOR AR8600, SmartSDR

Instellingen ...

Settings

General | Radio | Audio | Tx Macros | Reporting | Frequencies | Colors | Advanced

Station Details

My Call: My Grid: IARU Region:

Message generation for type 2 compound callsign holders:

Display

Blank line between decoding periods

Display distance in miles

Tx messages to Rx frequency window

Show DXCC entity and worked before status

Behavior

Monitor off at startup Enable VHF/UHF/Microwave features

Monitor returns to last used frequency Allow Tx frequency changes while transmitting

Double-click on call sets Tx enable Single decode

Disable Tx after sending 73 Decode after EME delay

CW ID after 73 Tx watchdog:

Periodic CW ID Interval:

Instellingen ...

Settings

General | **Radio** | Audio | Tx Macros | Reporting | Frequencies | Colors | Advanced

Rig: OmniRig Rig 1 Poll Interval: 1 s

CAT Control

Serial Port: []

Serial Port Parameters

Baud Rate: 4800

Data Bits

Seven Eight

Stop Bits

One Two

Handshake

None XON/XOFF Hardware

Force Control Lines

DTR: [] RTS: []

PTT Method

VOX CAT DTR RTS

Port: COM1

Transmit Audio Source

Rear/Data Front/Mic

Mode

None USB Data/Pkt

Split Operation

None Rig Fake It

Test CAT Test PTT

OK Cancel

Instellingen ...

The screenshot shows a Windows-style dialog box titled "Settings" with a standard window control bar (minimize, maximize, close). The "Audio" tab is selected among several tabs: General, Radio, Audio, Tx Macros, Reporting, Frequencies, Colors, and Advanced. The "Soundcard" section contains two dropdown menus: "Input" is set to "Realtek HD Audio Input" and "Output" is set to "Realtek HD Audio output". To the right of each dropdown are smaller dropdowns for "Mono" and "Both". The "Save Directory" section has a text field containing "C:/Documents and Settings/jj.derey/Local Settings/Application Data/WSJT-X/save" and a "Select" button. The "AzEl Directory" section has a text field containing "C:/Documents and Settings/jj.derey/Local Settings/Application Data/WSJT-X" and a "Select" button. The "Remember power settings by band" section has two checked checkboxes: "Transmit" and "Tune". At the bottom right, there are "OK" and "Cancel" buttons.

Settings

General | Radio | **Audio** | Tx Macros | Reporting | Frequencies | Colors | Advanced

Soundcard

Input: Realtek HD Audio Input Mono

Output: Realtek HD Audio output Both

Save Directory

Location: C:/Documents and Settings/jj.derey/Local Settings/Application Data/WSJT-X/save Select

AzEl Directory

Location: C:/Documents and Settings/jj.derey/Local Settings/Application Data/WSJT-X Select

Remember power settings by band

Transmit Tune

OK Cancel

Instellingen ... max 13 !

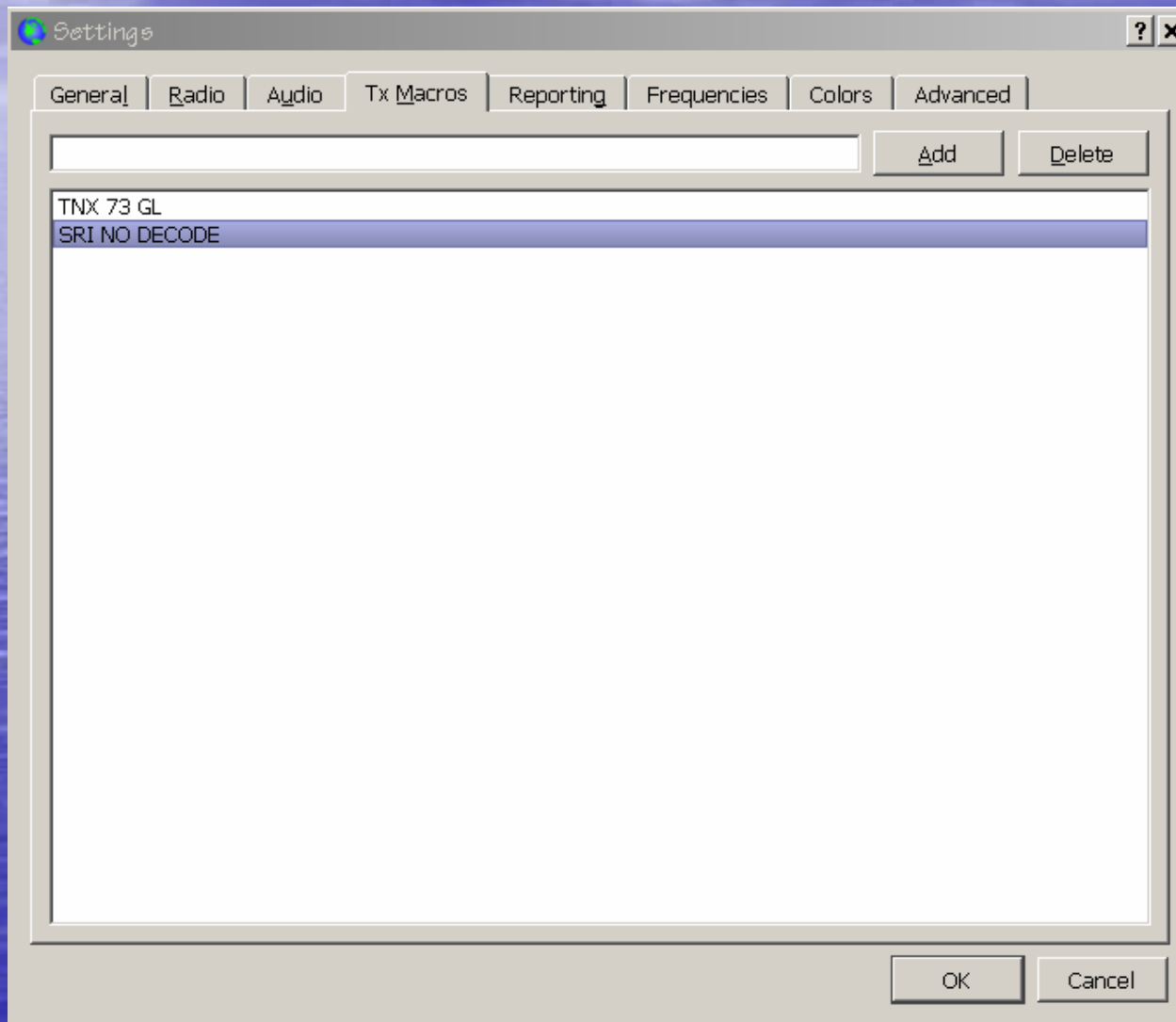

Instellingen ...

Settings

General | Radio | Audio | Tx Macros | Reporting | Frequencies | Colors | Advanced

Logging

- Prompt me to log QSO
- Convert mode to RTTY
- dB reports to comments
- Clear DX call and grid after logging

Network Services

- Enable PSK Reporter Spotting

UDP Server

UDP Server: Accept UDP requests

UDP Server port number: Notify on accepted UDP request

Accepted UDP request restores window

OK Cancel

Instellingen ...

Settings

General | Radio | Audio | Tx Macros | Reporting | **Frequencies** | Colors | Advanced

Frequency Calibration

Slope: 0,0000 ppm Intercept: 0,00 Hz

Working Frequencies

IARU Region	Mode	Frequency
All	WSPR	0,136 000 MHz (2190m)
All	JT65	0,136 130 MHz (2190m)
All	JT9	0,136 130 MHz (2190m)
Region 1	FreqCal	0,198 000 MHz (OOB)

Station Information

Band	Offset	Antenna Description
40m	0,000 000 MHz	Whip 2m long

OK Cancel

Instellingen ...

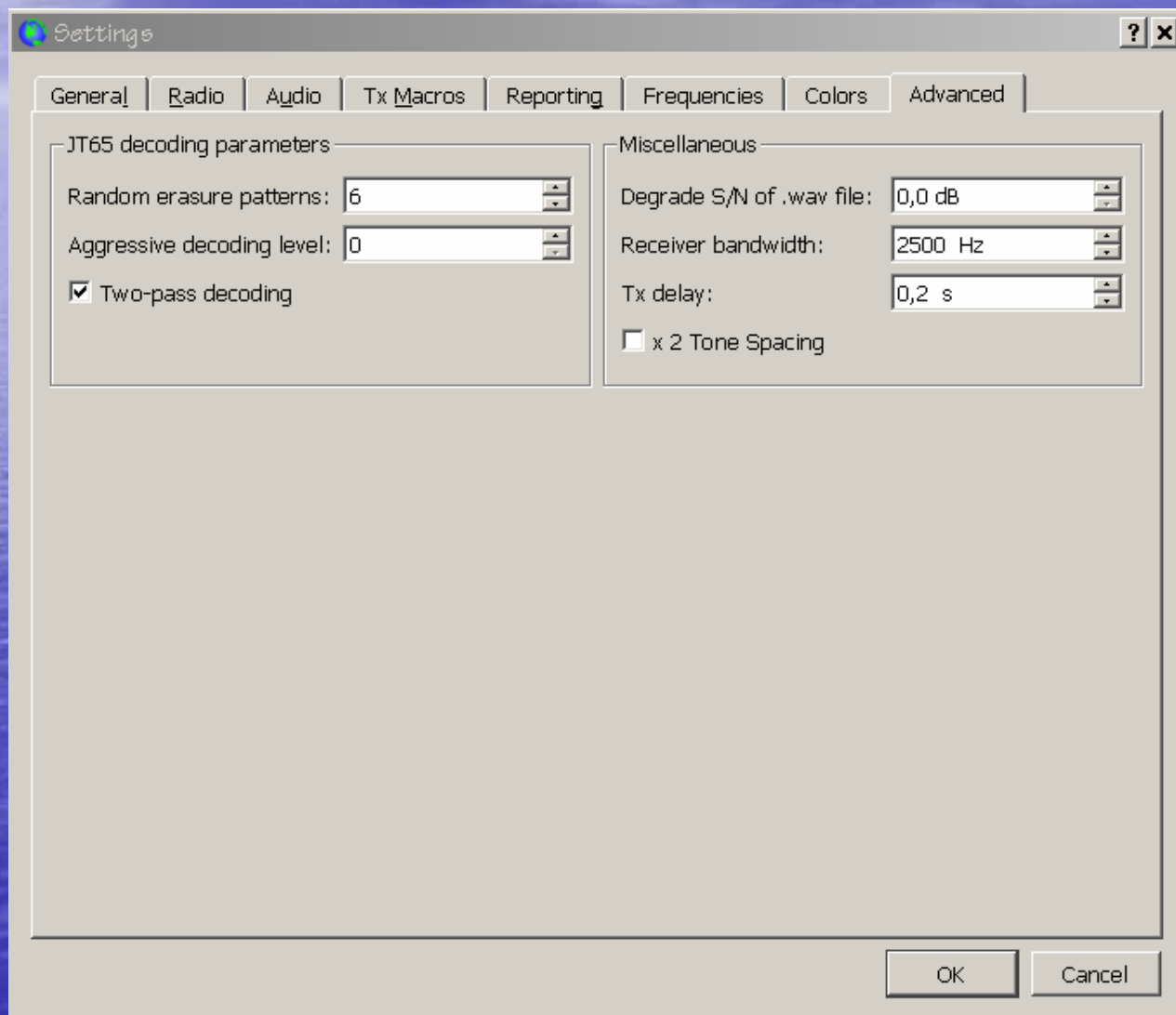

Instellingen ...



Monitor ON

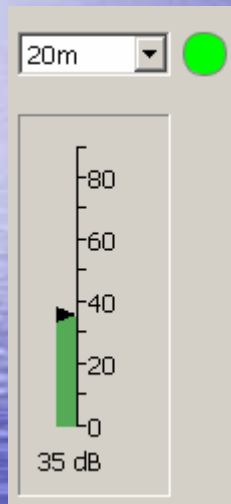

**Geen CAT ? Juiste frequentie !
(log+PSK reporter)**

RX level in groen (midden)

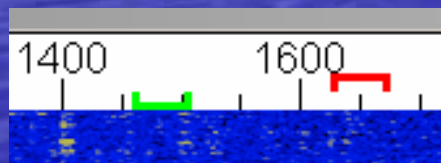

Waterfall :

ROOD = T X

GROEN = R X

Mijn eerste QSO ...

- Shortcuts / special mouse controls : F3 en F5

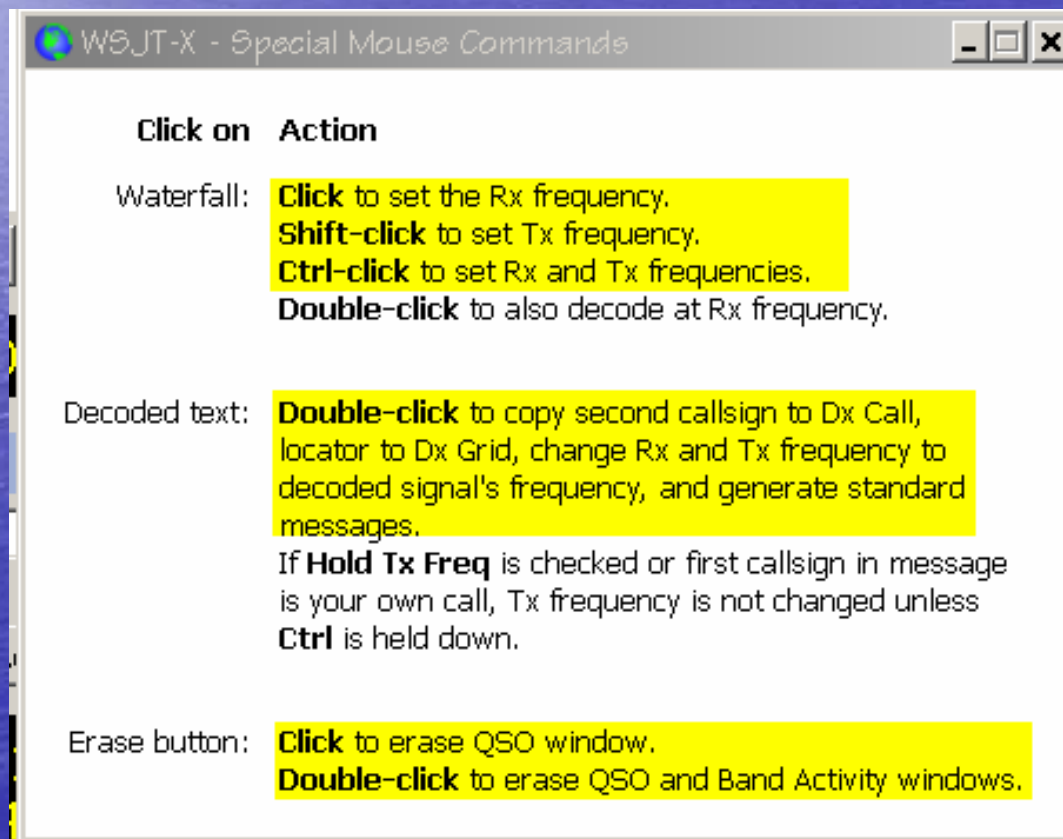

Mijn eerste QSO ...

- Stel je vermogen in met de **TUNE** – ! ALC uitslag!
- Keuze Audio Frequency
 - Kijk eerst 1 min naar waterfall – waar zijn er 'gaten' ?
 - Kies een vrij 'slot'
 - Liefst > dan 1500 Hz (2de harmonische), < 2100 Hz
 - DX station (pile-up) : niet op zijn TX gaan zitten !
 - Liefst '**HOLD TX FREQUENCY**' zeker als je CQ ('split')
 - '**AUTO SEQ**' aanvinken
 - **CALL 1st** aanvinken (als je CQ roept, automatisch QSO start)

Mijn eerste QSO ... tips !

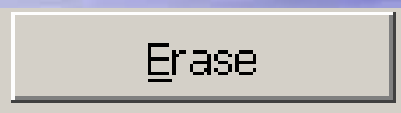

1x klikken = wissen RX venster
Dubbelklik = wissen beide vensters

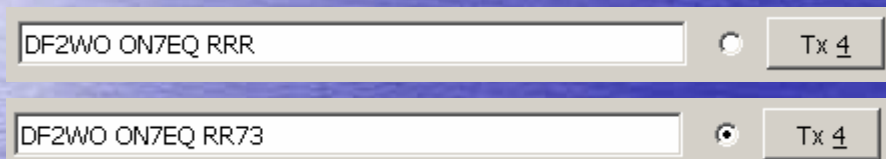

Dubbelklik op TX4 = RRR of RR73

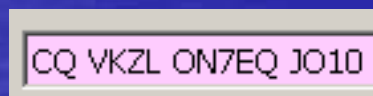
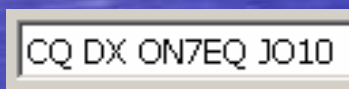
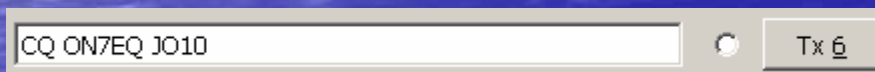

Tx 1628 ~ CQ VKZL ON7EQ

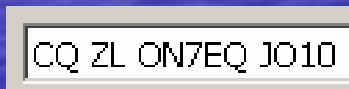

**Gerichte CQ : bijtikken in venster TX6 ! NIET in
free text veld – autoSEQ werkt NIET**

Besluiten ... FT8 is :

- een leuke mode om mee te experimenteren, vooral voor 'bescheiden opstelling' / QRP
- eenvoudig in installatie en gebruik
- in de 'achtergrond' te laten lopen
- gratis!
- *'Digital modes come and go ... but **SSB, CW & RTTY** are here to stay !'* (eigen quote HI)

WSJT-X v1.8.0 by K1JT

File Configurations View Mode Decode Save Tools Help

Band Activity					Rx Frequency				
UTC	dB	DT	Freq	Message	UTC	dB	DT	Freq	Message
192345	-5	0.6	2466	~ CQ R1KAG KN64					
192345	-13	0.7	1545	~ SV8JNL VK3SIM RRR					
----- 20m -----									
192400	-5	1.1	797	~ CQ DX TA1BZ KN41					
192400	-14	1.9	933	~ YU8NU IT9FAF JM67					
192400	0	1.0	1439	~ M6DOA UT3GX KN66					
192400	-7	1.5	1543	~ VK3SIM SV8JNL R-21					
192400	-14	1.1	1865	~ CQ E76C JN84					
192400	0	1.7	2026	~ PB7TT LZ2PR R-10					

Log QSO Stop Monitor Erase Decode Enable Tx Halt Tx Tune Menus

20m 14,074 000 Tx even/1st

DX Call: DF2WO DX Grid: Tx 1628 Hz Rx ← Rx Rx 1460 Hz Rx ← Tx Hold Tx Freq

Lookup Add Report -15 Auto Seq Call 1st NA VHF Contest

2017 Nov 15 19:24:29

Generate Std Msgs: Next Now Pwr

- DF2WO ON7EQ JO10 Tx 1
- DF2WO ON7EQ -15 Tx 2
- DF2WO ON7EQ R-15 Tx 3
- DF2WO ON7EQ RRR Tx 4
- DF2WO ON7EQ 73 Tx 5
- CQ ON7EQ JO10 Tx 6

Receiving FT8 14/15 WD:5m

WSJT-X - Wide Graph

Controls 600 800 1000 1200 1400 1600 1800 2000 2200

DEMO !